

# RIFUNZIONALIZZAZIONE EX SCUOLE ELEMENTARI CASAROLI DA DESTINARE A NUOVA SEDE DEGLI UFFICI COMUNALI 3° STRALCIO LAVORI

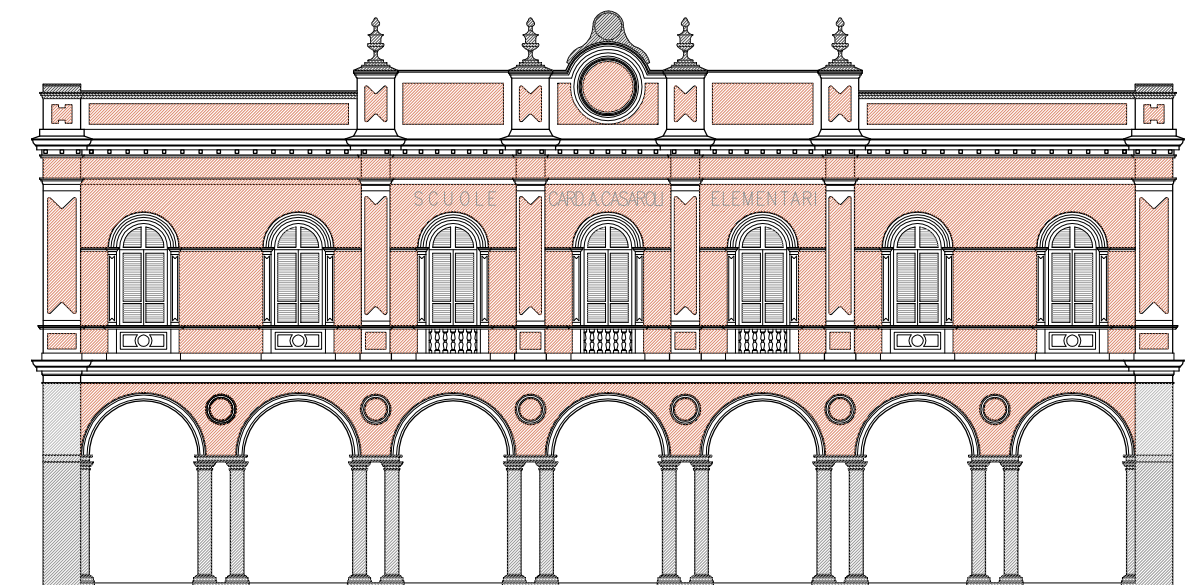

**Progetto PRELIMINARE**  
ai sensi art. 17 del D.P.R. 207/2010

**Progetto DEFINITIVO**  
ai sensi art. 24 del D.P.R. 207/2010



**Progetto ESECUTIVO**  
ai sensi art. 33 del D.P.R. 207/2010

## ABACO DEI SERRAMENTI

COMMITTENTE

**Comune di Castel San Giovanni**



Piazza XX Settembre n° 2    Tel. + 39 0523 889611  
29015 Castel San Giovanni    Fax + 39 0523 843882  
Piacenza    E mail comune.castelsangiovanni@sintranet.it

COORDINATORE GRUPPO DI PROGETTAZIONE  
PROGETTISTA ARCHITETTONICO  
COORDINATORE SICUREZZA IN FASE DI  
PROGETTAZIONE

**STUDIO ASSOCIATO Archh. ODDI**



Corso G. Matteotti n° 66    Tel. + 39 0523 881310  
29015 Castel San Giovanni    Fax + 39 0523 881965  
Piacenza    E mail info@studiooddi.it

PROGETTISTA STRUTTURE

**ING. FERRUCCIO ROSSETTI**

Via Taverna n° 273    Tel. + 39 0523 484647  
29121 Piacenza    Fax + 39 0523 489268  
Piacenza    E mail info@rossetticanтони.it

PROGETTISTA IMPIANTI MECCANICI  
ED ELETTRICI

**STUDIO TECNICO ASSOCIATO PARENTI**



Via Fratelli Solari n° 17    Tel. + 39 0523 523157  
29027 Gariga di Podenzano    Fax + 39 0523 523157  
Piacenza    E mail massimo@staparenti.it

CODICE ELABORATO

**DS A 0019 III**

SCALA

**1:50**

REVISIONE  
02

DATA  
GENNAIO 2022

MOTIVO  
III STRALCIO FUNZIONALE

ESEGUITO  
Anna Cazzola

CONTROLLATO  
Bruno Oddi

APPROVATO  
Giuseppe Oddi

seminterrato

esterno/interno

ferro

## LEGENDA



PARTE CIECA



VETRO TRASPARENTE

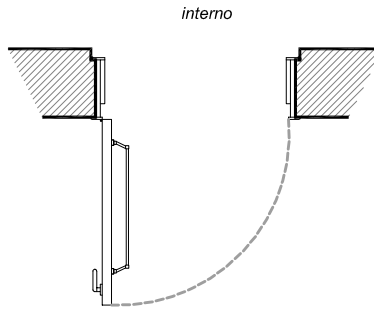
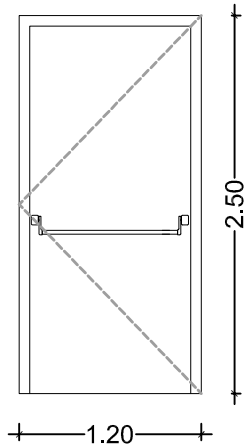

VETRO OPALINO

*vista frontale**pianta**quantità, descrizione, locali di installazione*

N. 1 - PORTA  
SERRAMENTO IN FERRO A  
UN'ANTA APRIBILE VERSO  
L'ESTERNO CON MANIGLIONE  
ANTIPANICO  
LOC. S13

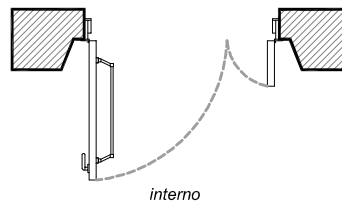
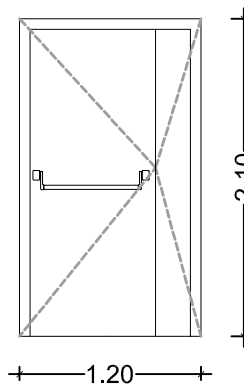

N. 1 - PORTA REI 90  
SERRAMENTO TAGLIAFUOCO  
IN FERRO A DUE ANTE  
APRIBILE VERSO L'INTERNO  
CON MANIGLIONE  
ANTIPANICO  
LOC. S13

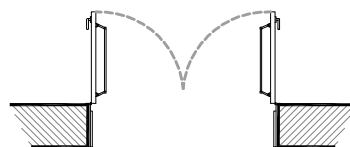
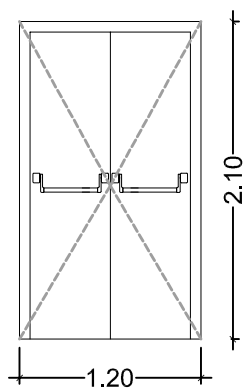

N.2 - PORTA REI 90  
SERRAMENTO TAGLIAFUOCO  
IN FERRO CON DUE ANTE A  
BATTENTE E MANIGLIONI  
ANTIPANICO  
LOC. S18

seminterrato

interno

ferro/legno

## LEGENDA



PARTE CIECA



VETRO TRASPARENTE

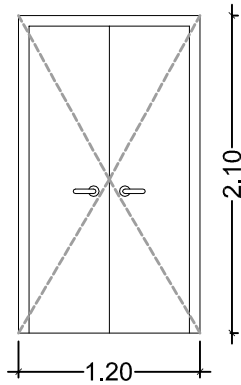

VETRO OPALINO

*vista frontale**pianta**quantità, descrizione, locali di installazione*

**N. 3 - PORTA**  
**SERRAMENTO IN LEGNO CON**  
**DUE ANTE A BATTENTE**  
**LOC. S14 - S15 - S16**

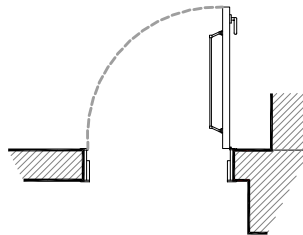
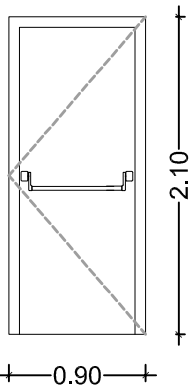

**N. 1 - PORTA REI 90**  
**SERRAMENTO TAGLIAFUOCO**  
**IN FERRO CON UN'ANTA A**  
**BATTENTE, APERTURA CON**  
**MANIGLIONE ANTIPANICO**  
**LOC. S17**

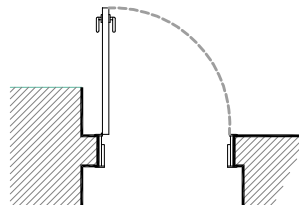
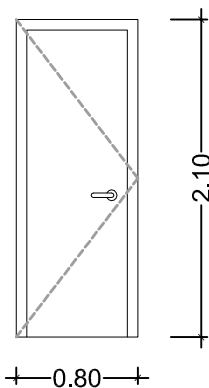

**N. 1 - PORTA**  
**SERRAMENTO IN LEGNO CON**  
**UN'ANTA A BATTENTE**  
**LOC. S20**

rialzato

interno

ferro

## LEGENDA



PARTE CIECA



VETRO TRASPARENTE

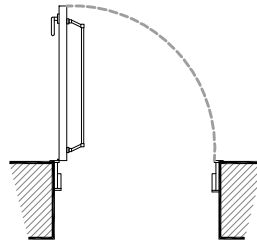
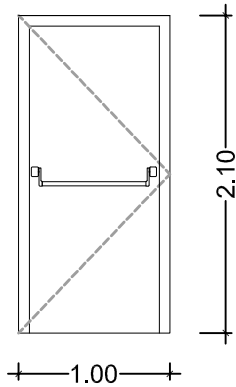

VETRO OPALINO

*vista frontale**pianta**quantità, descrizione, locali di installazione*

N. 1 - PORTA REI 60  
 SERRAMENTO TAGLIAFUOCO  
 IN FERRO CON UN'ANTA A  
 BATTENTE E MANIGLIONE  
 ANTIPANICO  
 LOC. T9

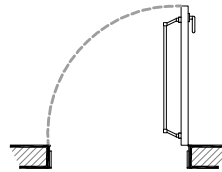
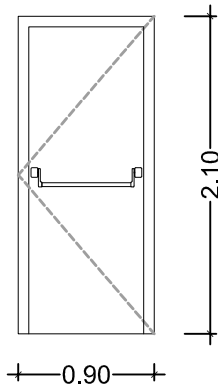

N. 2 - PORTA REI 60  
 SERRAMENTO TAGLIAFUOCO  
 IN FERRO CON UN'ANTA A  
 BATTENTE E MANIGLIONE  
 ANTIPANICO  
 LOC. T8 - T10

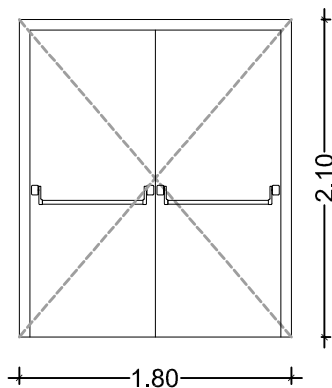

N. 1 - PORTA REI 60  
 SERRAMENTO TAGLIAFUOCO  
 IN FERRO A DUE ANTE E  
 MANIGLIONE ANTIPANICO  
 LOC. T23

rialzato

interno

legno

## LEGENDA



PARTE CIECA



VETRO TRASPARENTE

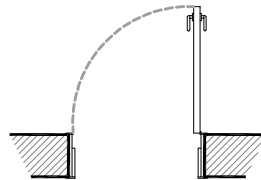
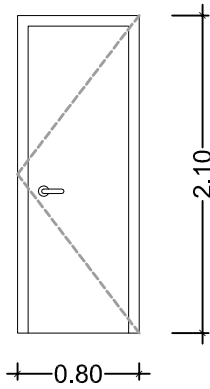
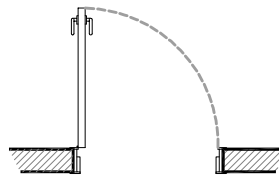
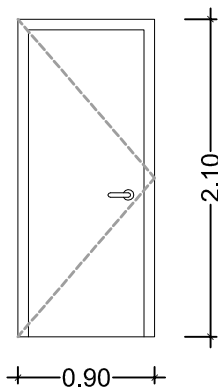

VETRO OPALINO

*vista frontale**pianta**quantità, descrizione, locali di installazione***N. 15 - PORTA****SERRAMENTO IN LEGNO CON  
UN'ANTA A BATTENTE****LOC. T10 - T20 - T21 - T22 - T23  
- T24****N.1 - PORTA****SERRAMENTO IN LEGNO CON  
UN'ANTA A BATTENTE****LOC. T10**

primo

interno

ferro

## LEGENDA



PARTE CIECA



VETRO TRASPARENTE

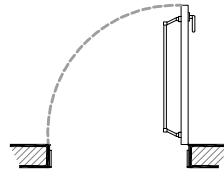
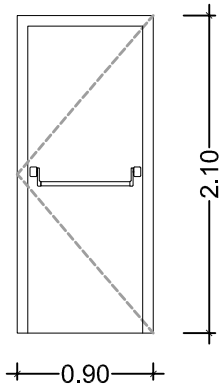

VETRO OPALINO

*vista frontale**pianta**quantità, descrizione, locali di installazione*

N. 2 - PORTA REI 60  
 SERRAMENTO TAGLIAFUOCO  
 IN FERRO CON UN'ANTA A  
 BATTENTE E MANIGLIONE  
 ANTIPANICO  
 LOC. P8 - P9

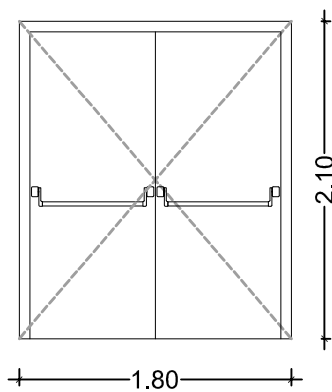

N. 1 - PORTA REI 60  
 SERRAMENTO TAGLIAFUOCO  
 IN FERRO A DUE ANTE E  
 MANIGLIONE ANTIPANICO  
 LOC. P24

## LEGENDA



PARTE CIECA



VETRO TRASPARENTE

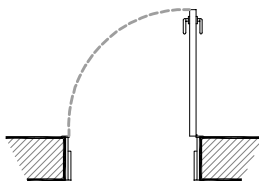
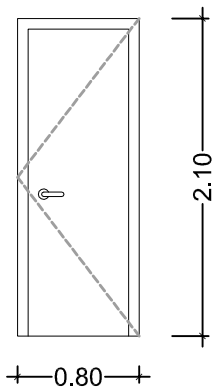
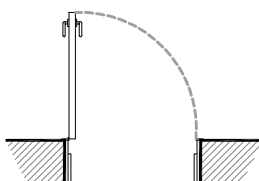
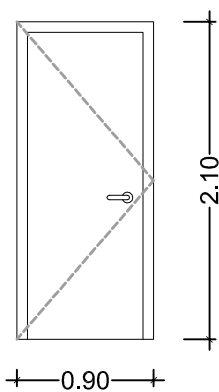

VETRO OPALINO

*vista frontale**pianta**quantità, descrizione, locali di installazione***N. 15 - PORTA****SERRAMENTO IN LEGNO CON UN'ANTA A BATTENTE****LOC. P8 - P9 - P20 - P21 - P22 - P23 - P24****N. 1 - PORTA****SERRAMENTO IN LEGNO CON UN'ANTA A BATTENTE****LOC. P8**